

THE BARD'S LORE I MAPBOOK

1. THE CITY OF LORRAINE

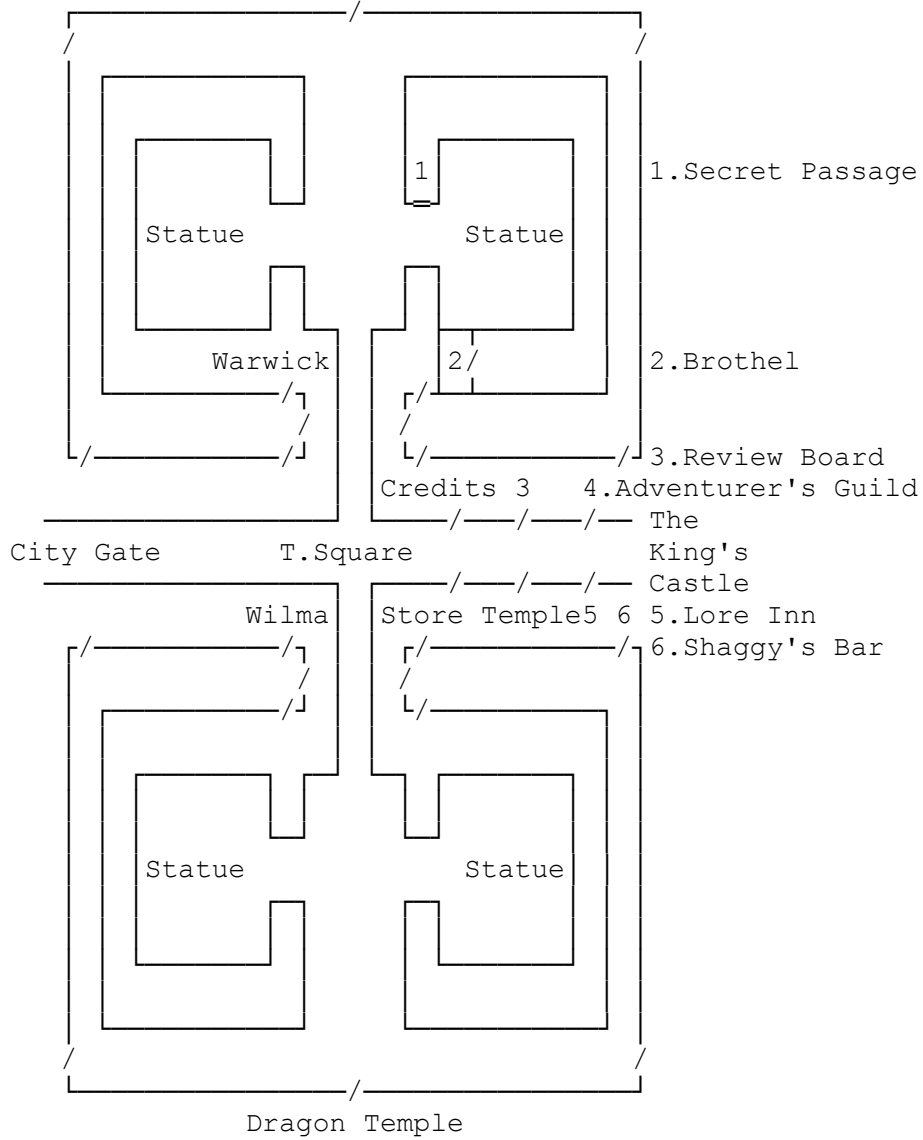

2.SHAGGY'S CELLAR

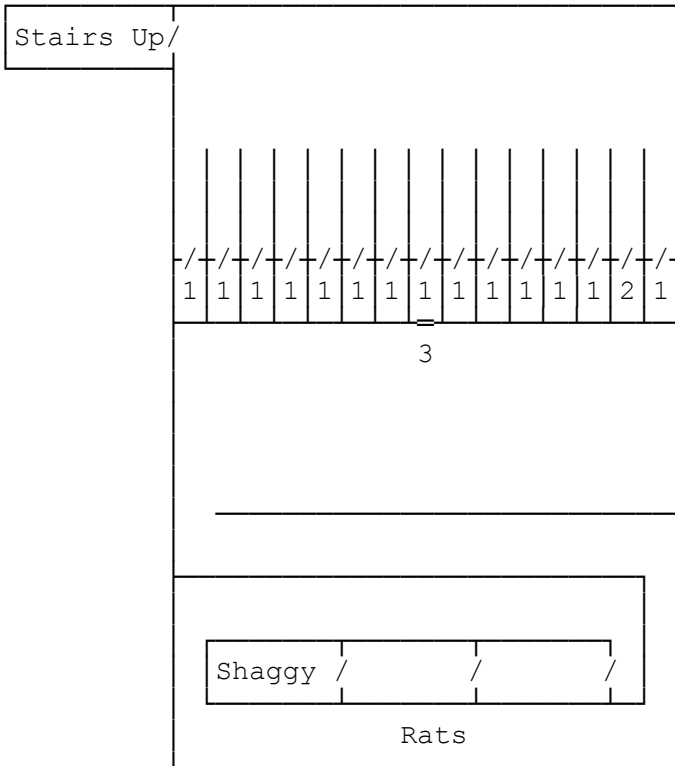

- 1.Chest w/ Ratshit
- 2.Chest w/ Matches
- 3.Secret Door

3.DRAGON TEMPLE Level 1

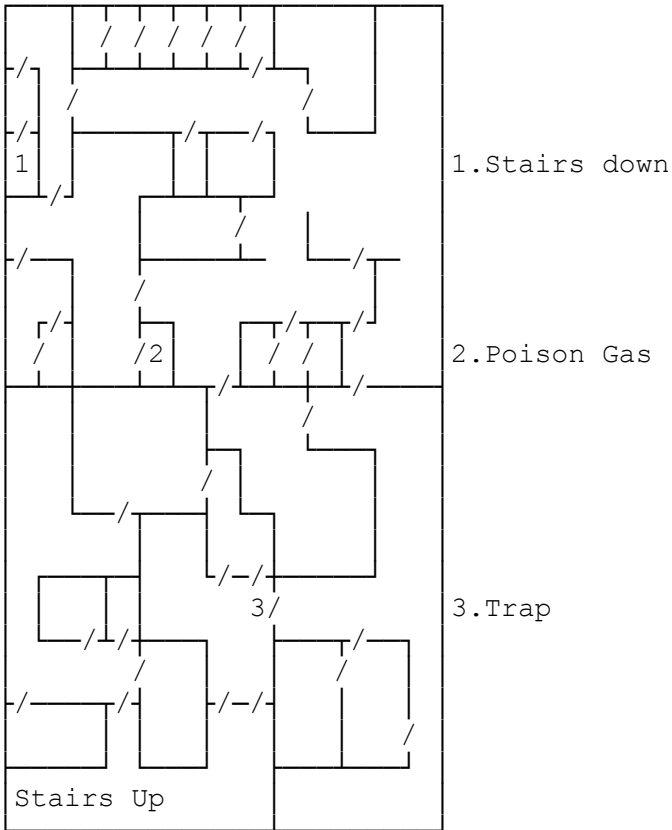

4.DRAGON TEMPLE Level 2

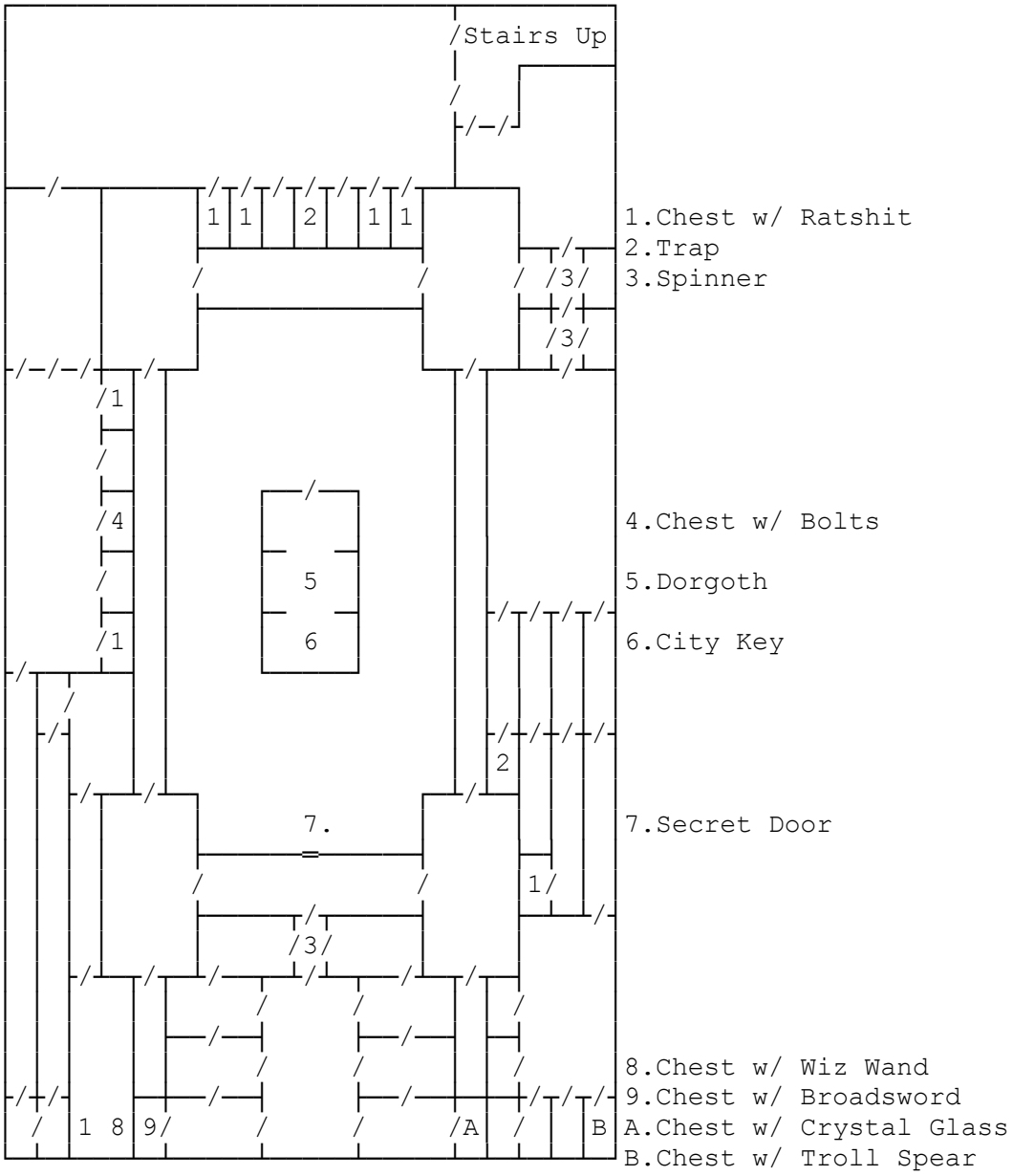

5. WILDERNESS

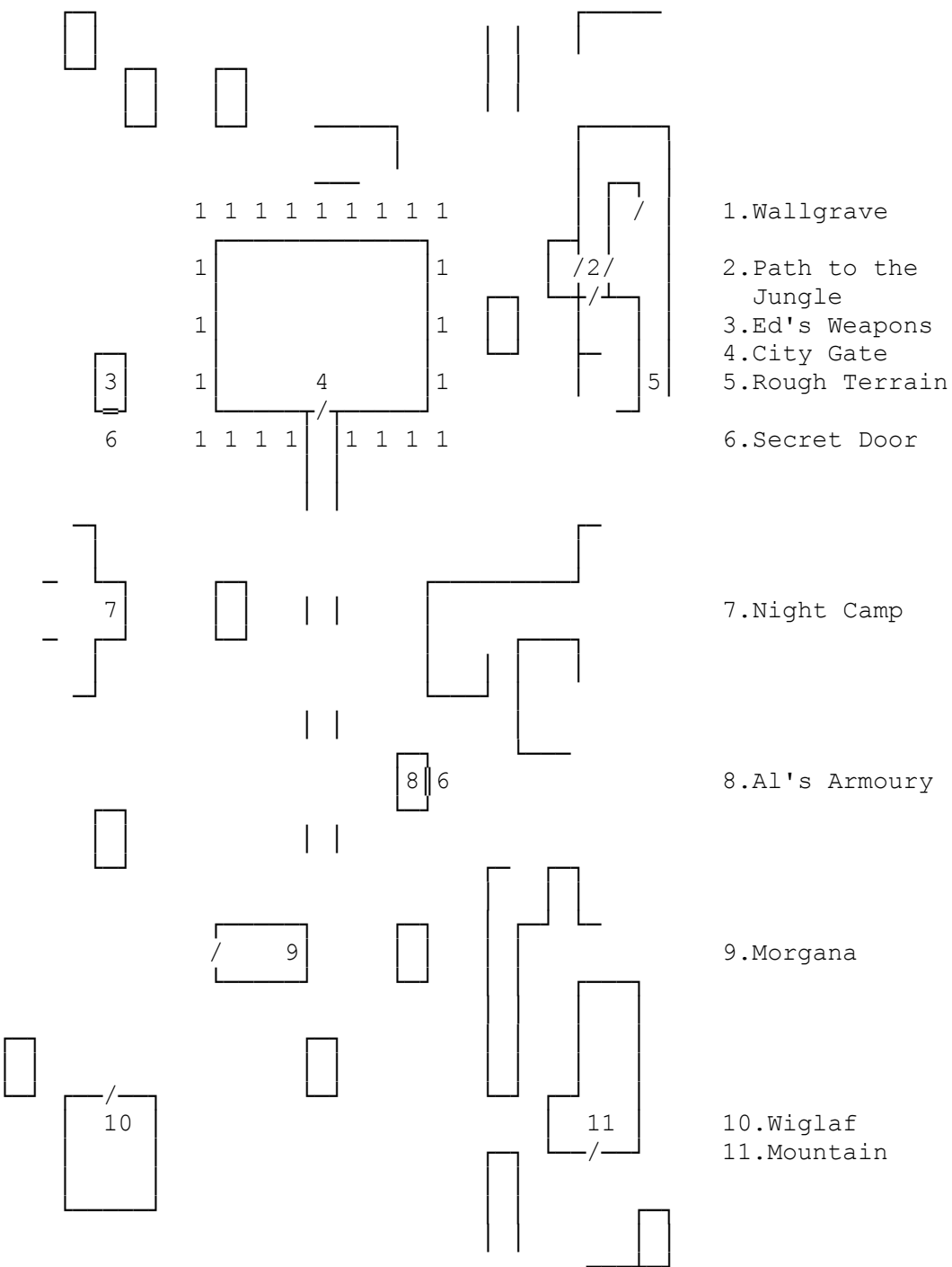

- 1. Wallgrave
- 2. Path to the Jungle
- 3. Ed's Weapons
- 4. City Gate
- 5. Rough Terrain
- 6. Secret Door

7. Night Camp

8. Al's Armoury

9. Morgana

10. Wiglaf

11. Mountain

6. JUNGLE

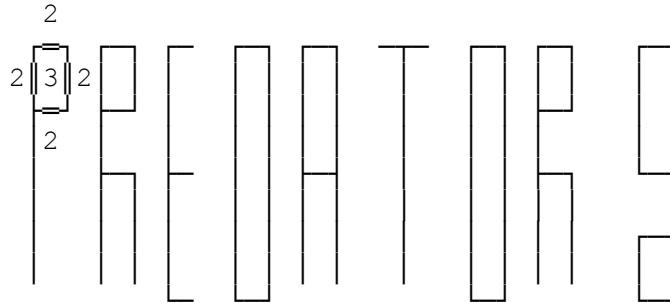
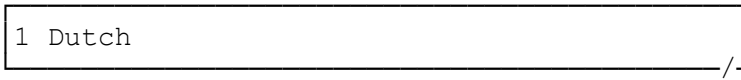

1.To Wilderness

2.Secret Door

3.Lair

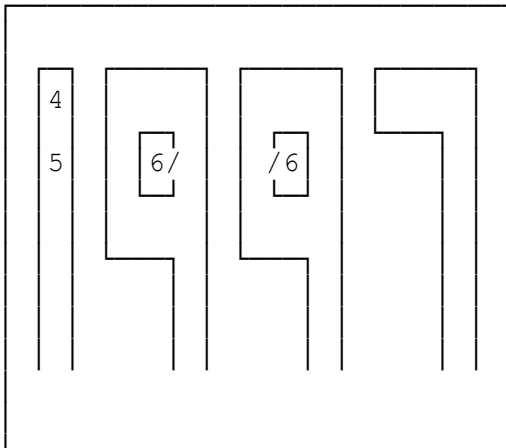

4.Trail

5.A Note

6.Teleporter

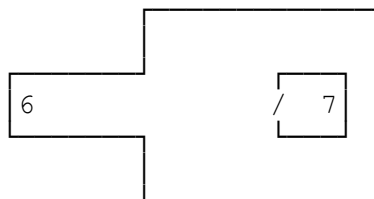

7.Saruman

7.MOUNTAIN Level 1

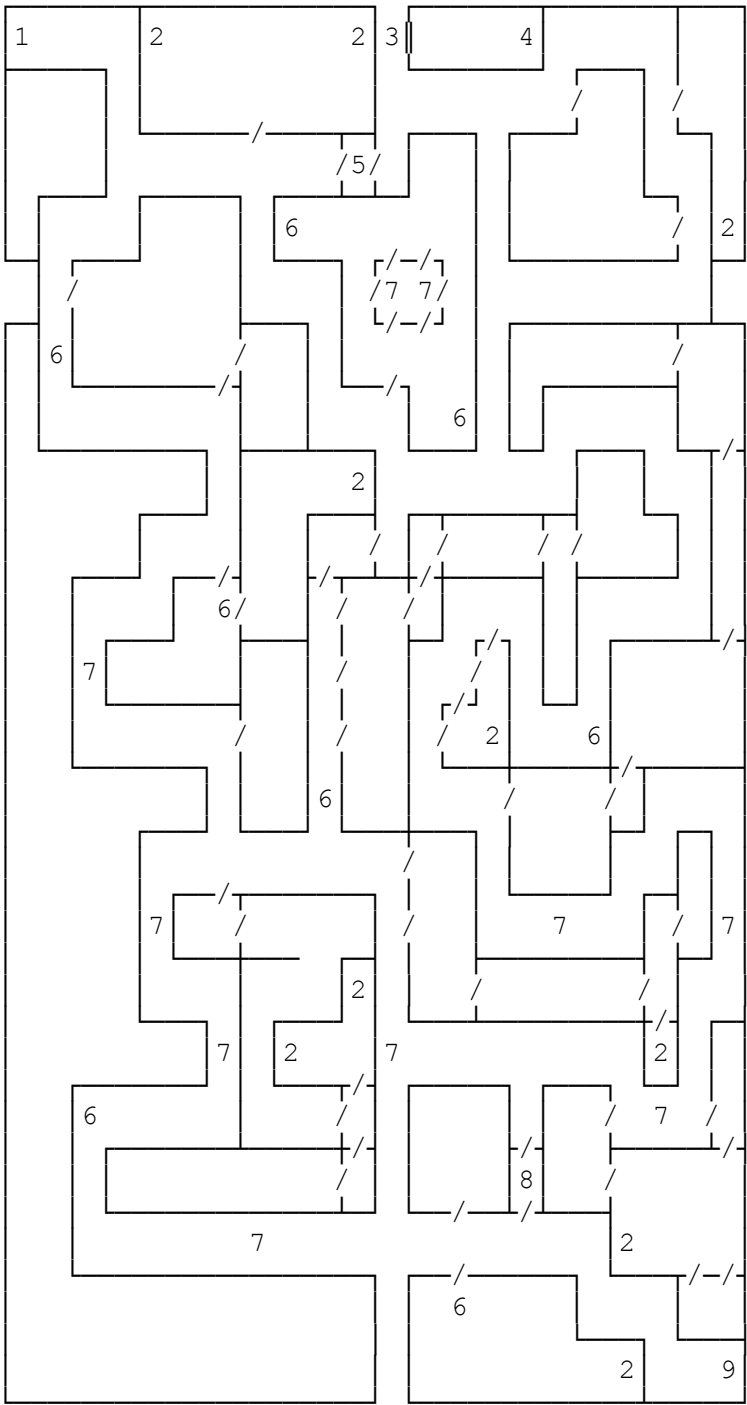

- 1.Stairs Down
- 2.Chest w/ Idol Statue
- 3.Secret Door
- 4.Treasure
- 5.Ripley
- 6.Trap
- 7.Spinner
- 8.Alien
- 9.Stairs Up

8.MOUNTAIN Level 2

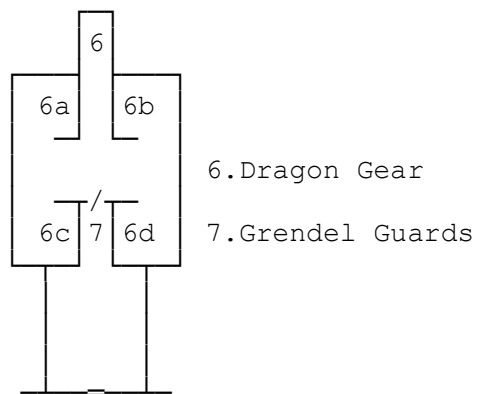
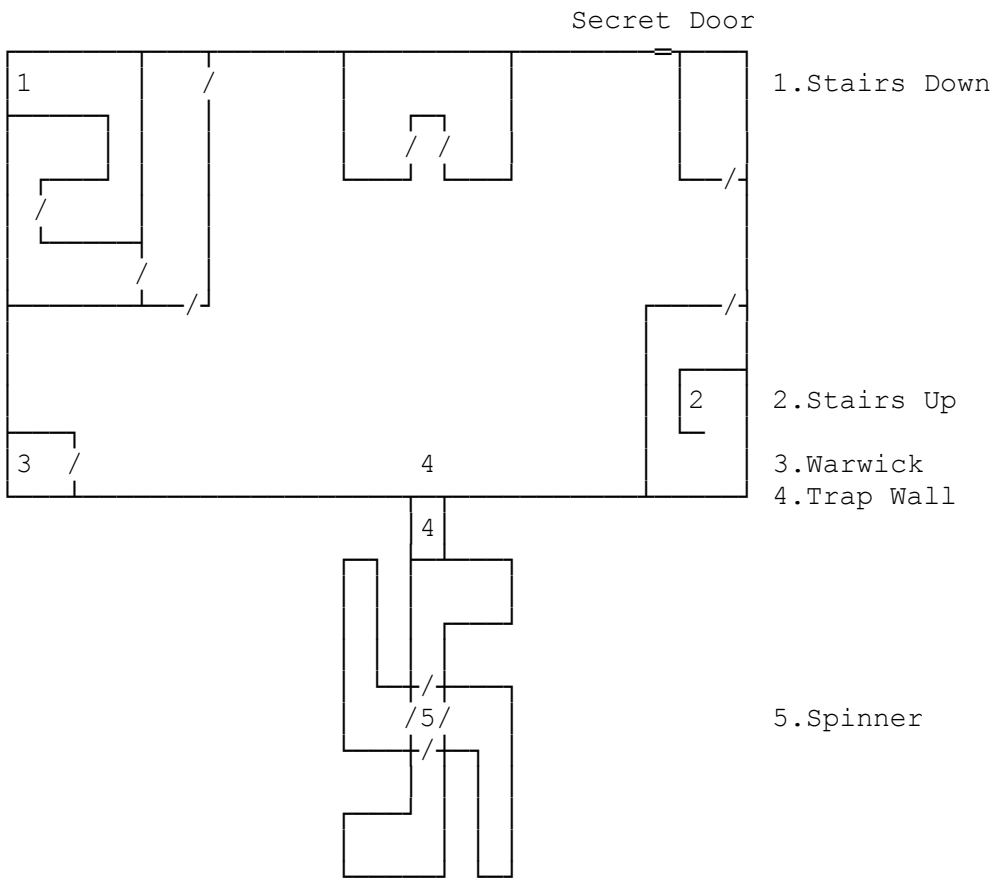

10. BLANK MAP

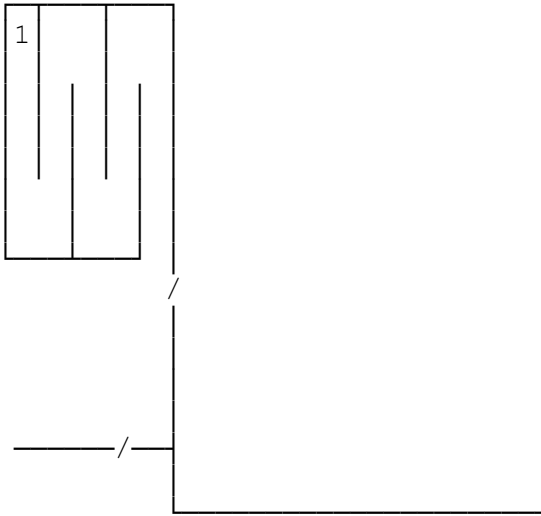

1. Passage

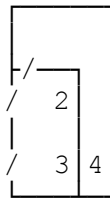

- 2. End Screen
- 3. Title Screen
- 4. The Queen topless at the pool

